

DCC-9-BOX Splitter Box

DCC-9-BOX is a splitter box specifically designed to make a building's electrical infrastructures fully ready for electric vehicles at the lowest possible price.

It allows the connection of the main power supply and the power supply of the EV charger while reducing the initial cost of installation.

Each DCC-BOX model can be supplemented to allow connection of an EV charger by adding the DCC-9-PCB-XXA electronic infrastructure.

FEATURES

The DCC-9-BOX can be powered by a 240/208V AC single phase source, max 125A.

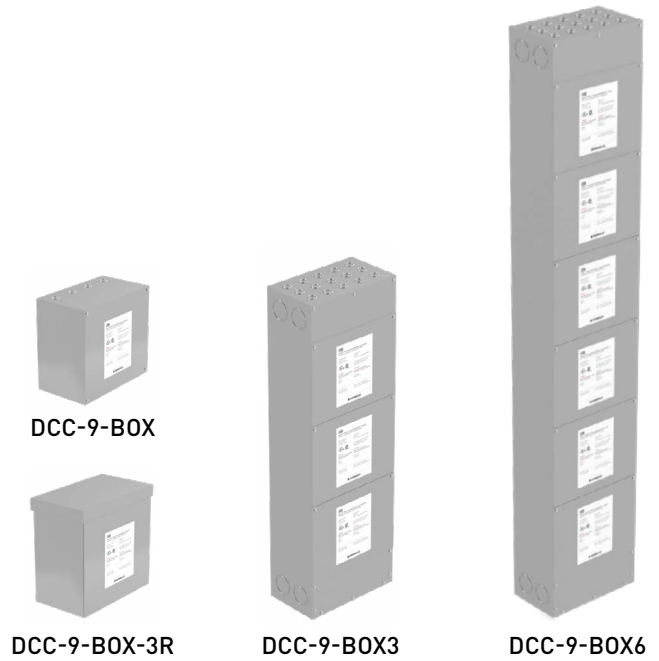

Models	Main power supply								Dimensions* (H" x W" x D")	Total weight*
	60A	70A	80A	90A	100A	125A	150A	200A		
DCC-9-BOX	✓	✓	✓	✓	✓	✓	✗	✗	12" x 12" x 7.5"	11 lb (4,99 kg)
DCC-9-BOX-3R	✓	✓	✓	✓	✓	✓	✗ SEE DCC-11	✗	14" x 13" x 8"	12 lb (5,44 kg)
DCC-9-BOX3	✓	✓	✓	✓	✓	✓	✗	✗	39" x 14" x 9"	40.5 lb (18,37 kg)
DCC-9-BOX6	✓	✓	✓	✓	✓	✓	✗	✗	78" x 14" x 9"	81 lb (36,74 kg)

Voltage and wiring 240/208V AC single phase: L1, L2, Neutral, Ground.

Terminals size up to 2/0 (CU/AL)

Certifications  

*Approximative and can change without notice.

V4



DCC-9-BOX

Splitter Box of the Electric Vehicle Energy Management System



DCC-9-PCB

Electronic Components of the Electric Vehicle Energy Management System



DCC-9

Electric Vehicle Energy Management System

The Different Models

DCC-9-BOX



DCC-9-BOX-3R

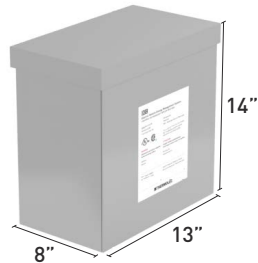

DCC-9-BOX3



DCC-9-BOX6

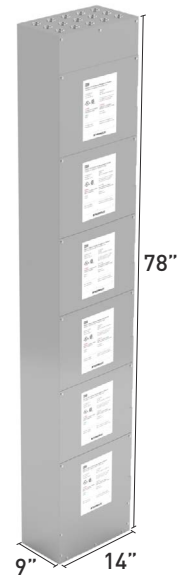

INSTALLATION CONTEXTS AND ADVANTAGES

- Suitable for small spaces with irregular configuration;
- Can easily be added to the electrical rooms of buildings already built.

INSTALLATION CONTEXTS AND ADVANTAGES

- Simplifies large-scale installations;
- Allows to save space and organize cable installation;
- Allows for a more ergonomic installation for the installer and minimizes the footprint.

INSTALLATION EXAMPLE

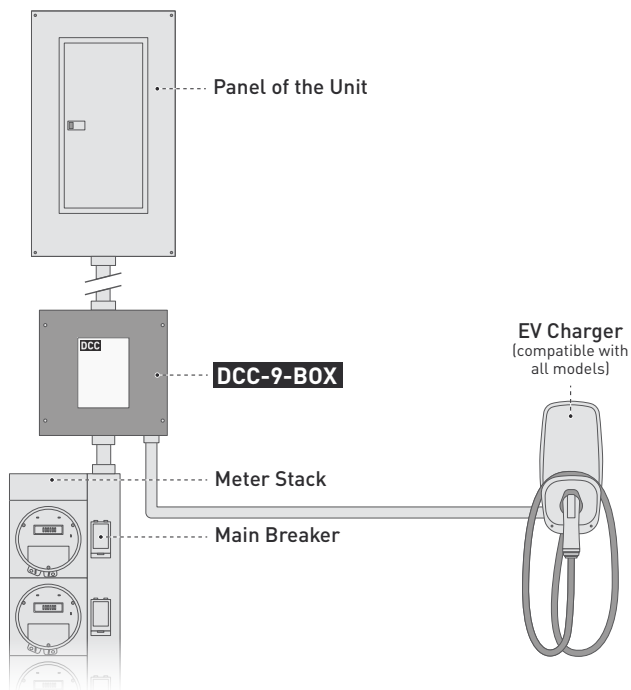

INSTALLATION EXAMPLE

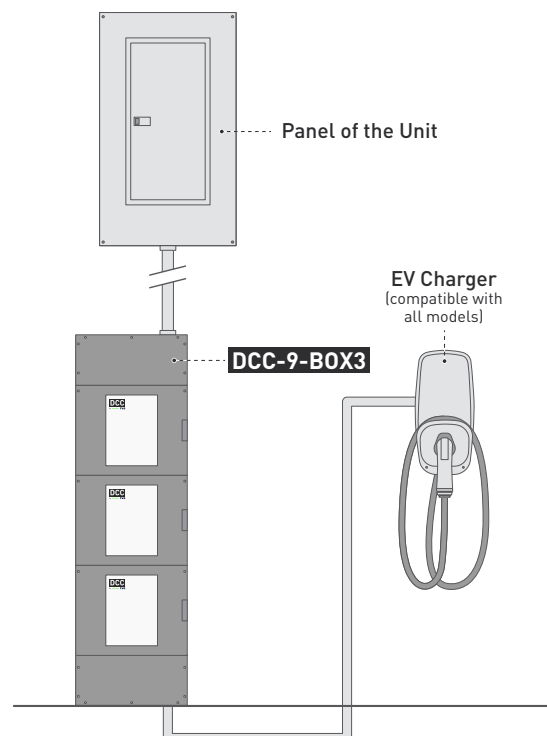

Knock Out Measures for DCC stack tub end

TOP (DCC-9-BOX3 AND DCC-9-BOX6)

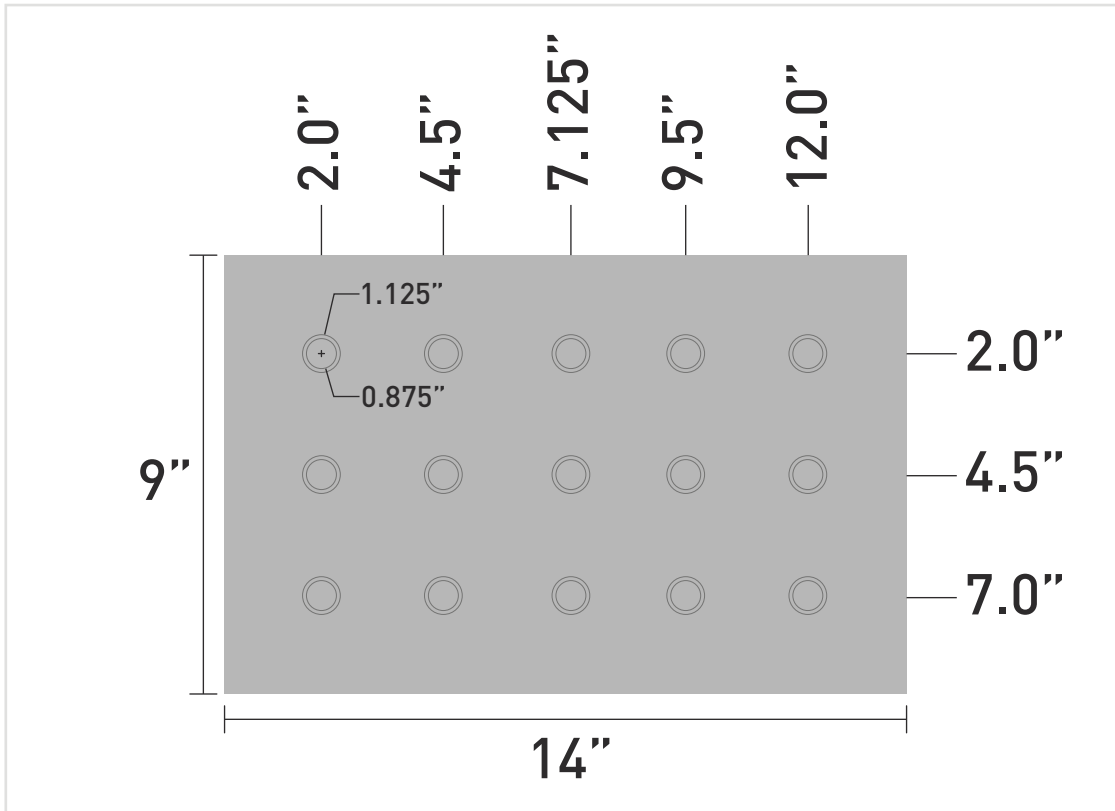

BOTTOM (DCC-9-BOX3 AND DCC-9-BOX6)

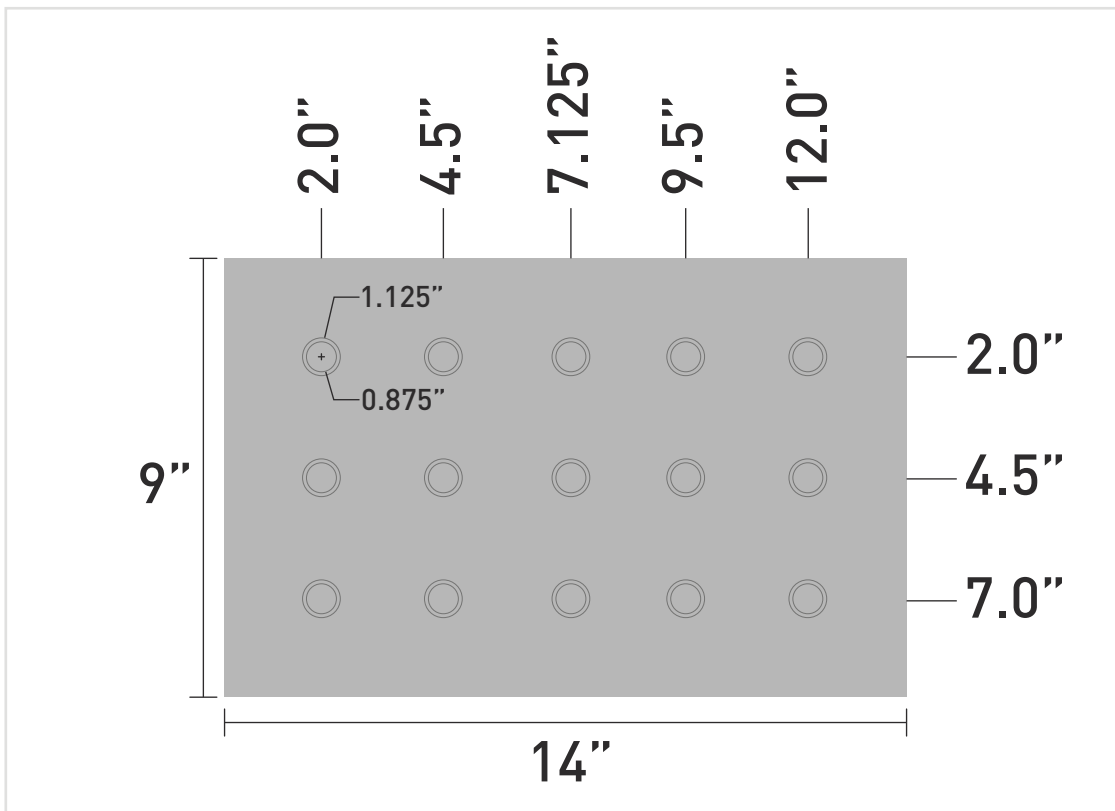

Installation Possibilities

INSTALLATION ON THE BACK OF A METER STACK

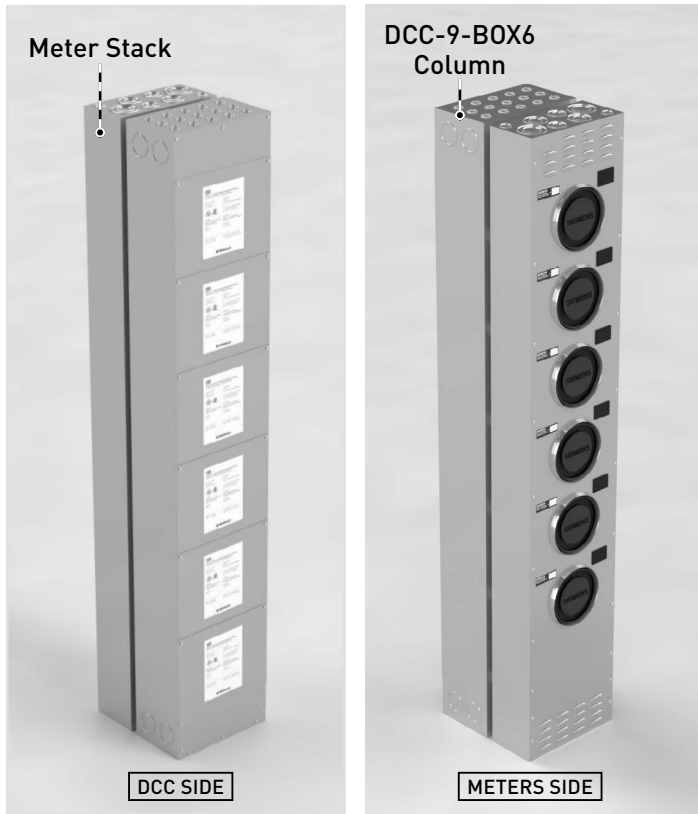

SIDE BY SIDE INSTALLATION

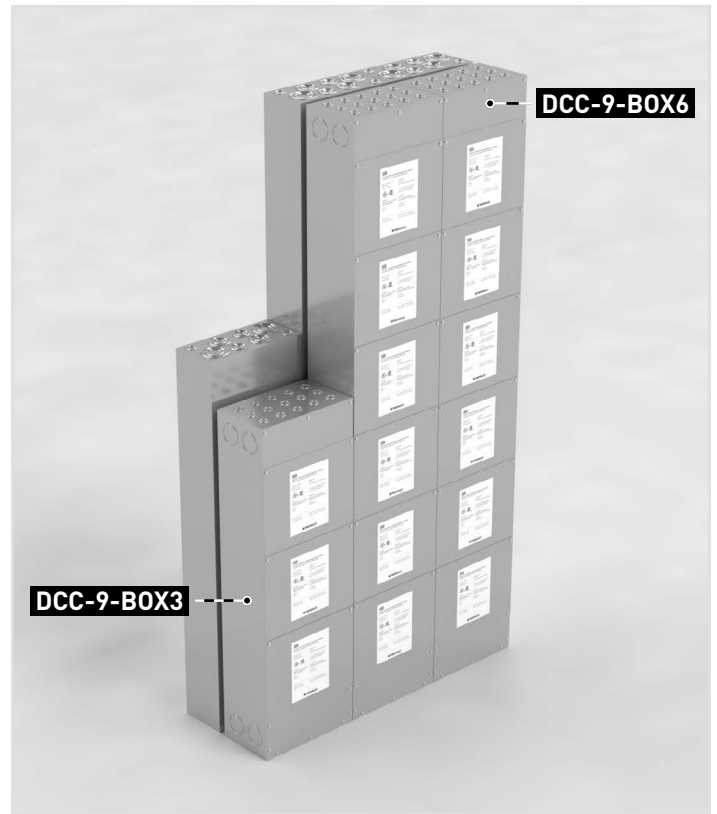

TOP POWER SUPPLY EXIT

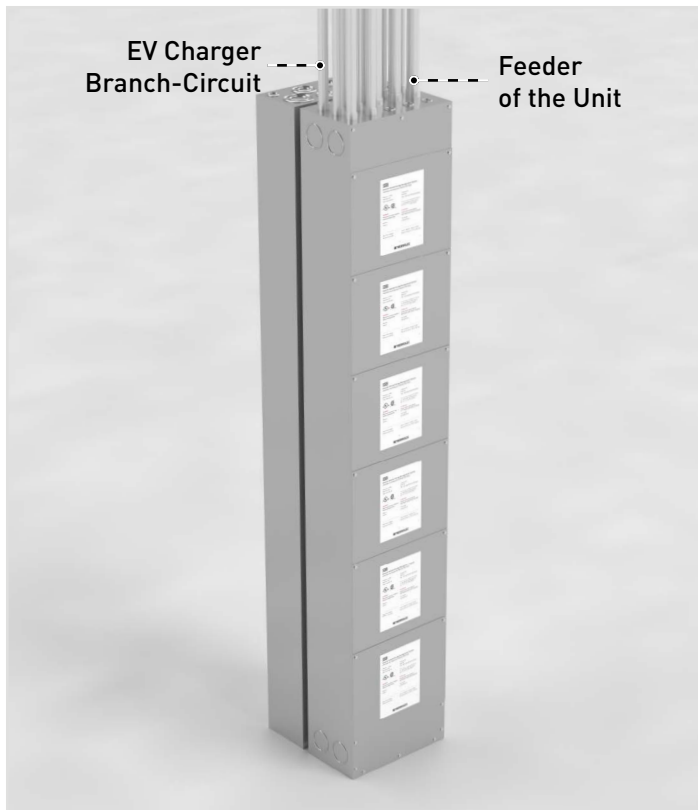

TOP AND BOTTOM POWER SUPPLY EXIT

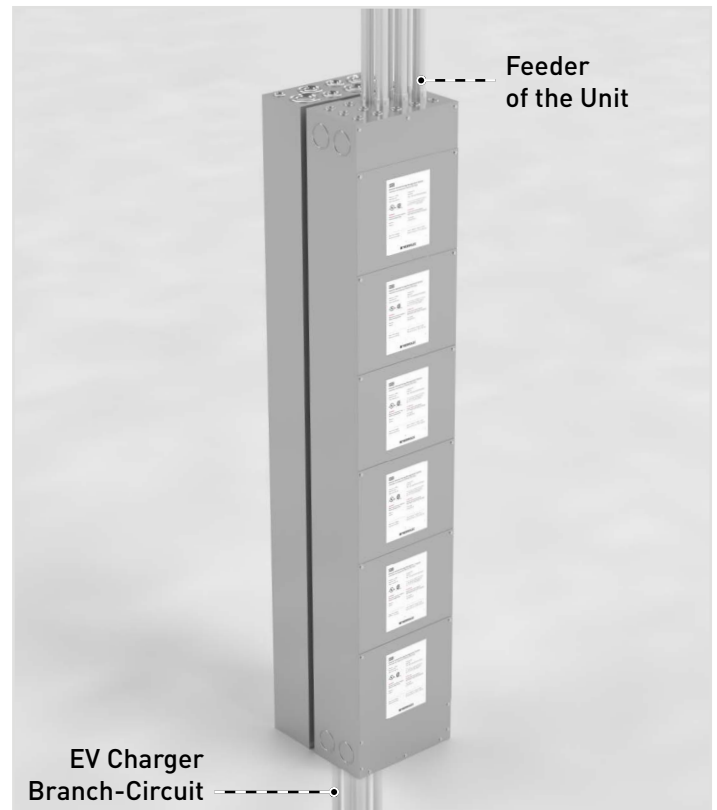

Please note that the DCC-9-BOX3 and DCC-9-BOX6 must be installed against a wall or a fixed structure. A freestanding installation is not possible.