

READ AND SAVE THESE INSTRUCTIONS

Installation manual

DCC – Charge controller for electric vehicle

DCC-9, DCC-10



Manufactured by

THERMOLEC

Designed by

rve
recharge véhicule
électrique



Patent Pending

V2-6 Avril 2017

Table of contents

ABOUT THIS MANUAL	3
SAFETY INFORMATION	4
SPECIFICATIONS	5
CHARACTERISTICS	6
TYPES OF CONNECTION	7
DCC INSTALLATION	7
APPLICATION	16
MAINTENANCE	16
LIGHTS CODE	17

About this manual

Errors and inaccuracies

For any inaccuracy or omission, or to forward any general comments or suggestions concerning the quality of this manual, please send an email to info@rve.ca.

Copyrights and Trade Names

All information's in this manual are subject to copyright and all other intellectual property protection of **THERMOLEC LTÉE. / RECHARGE VÉHICULE ÉLECTRIQUE** and its licensors. This installation manual cannot be modified, reproduced or copied without a prior written authorisation from **THERMOLEC LTÉE. / RECHARGE VÉHICULE ÉLECTRIQUE** and its licensors. Additional information's are available on request. The following logos are trade names or trademarks of **THERMOLEC LTÉE. / RECHARGE VÉHICULE ÉLECTRIQUE** in the United States and in Canada.



The **DCC – Charge controller for electric vehicle**



All other trade names mentioned in this document are the property of their respective owners and their uses in this manual does not means a sponsorship or approval of the product. The use of any trade name shown in this document is strictly forbidden.

In this document, the terms *DCC – Charge controller for electric vehicle* and DCC are equivalent.

Safety information

This document describes important safety instructions which must be followed during installation, maintenance and application of the *DCC – Charge controller for electric vehicle*.

Warning

Read all instructions prior using this product.

Always disconnect the *DCC – Charge controller for electric vehicle* power supply before any works.

Use only the *DCC – Charge controller for electric vehicle* by following the technical specifications indicated in this installation manual.

Do not install the *DCC – Charge controller for electric vehicle* nearby inflammable materials, explosives or fuels, chemical products and vapors.

Do not install the *DCC – Charge controller for electric vehicle* outdoor.

Never spray the *DCC – Charge controller for electric vehicle* with water or any other liquids.

DCC – Charge controller for electric vehicle
Stop using the *DCC – Charge controller for electric vehicle* immediately if defective, cracked, broken or damaged.

Never try to modify, repair or dismantle the *DCC – Charge controller for electric vehicle*. Please contact the manufacturer for any malfunction.

Never insert a sharp object inside the *DCC – Charge controller for electric vehicle* at the risk of causing damages to the components.

Any improper use of the *DCC – Charge controller for electric vehicle* could result in serious injuries which may cause death.

For a vertical installation on a wall, refer to the information's on the enclosure for the choice of mounting position.

Precautions

Any improper use of the *DCC – Charge controller for electric vehicle* can cause damages and premature wear of the components, which voids the warranty.

Never use the *DCC – Charge controller for electric vehicle* above or below temperatures ranging from 32 °F to 113 °F (0 °C to 45 °C).

The installation of the *DCC – Charge controller for electric vehicle* must be done in accordance with the latest electrical code requirements.

Notes

It is recommended to schedule the charging of the vehicle during hours of low electrical consumption to minimize interruptions to the electric charging station.

Always check that the *DCC – Charge controller for electric vehicle* is adequately fixed to the wall or ceiling or in a location to avoid any damages.

It is the installer's responsibility to make sure that the electric power source is adequate for the use of one or more *DCC*.

Do not use any cleaning solvents for cleaning the *DCC – Charge controller for electric vehicle*.

Limited warranty

1 - **THERMOLEC LTÉE.** warrants the integrated controls against any defects for a period of one year from the shipping date. The warranty is limited to the equipment and components supplier by **THERMOLEC LTÉE.**

2 – In case of incorrect installation, inappropriate use or repairs done by unauthorized personnel by **THERMOLEC LTÉE.**, the warranty will be automatically void.

3 - **THERMOLEC LTÉE.** undertakes to repair or replace, at site or at the manufacturing location, at his own option, the defective material only after an evaluation made by its representative.

4 - **THERMOLEC LTÉE.** will not be held liable for damages or delays and will not be

required to pay transport cost of the charge controller said to be defective.

5 - **THERMOLEC LTÉE.** shall not be liable for any indirect damages or delays caused by faulty workmanship or materials.

No indemnity will be paid for repairs, replacements or modifications without a prior written authorization from **THERMOLEC LTÉE.**

6 – Any control device or accessory supplied with the *DCC – Charge controller for electric*

vehicle to be installed or connected remotely from the charge controller will be guaranteed by the manufacturer only under the special conditions mentioned in paragraph 5.

7 – The components supplied for repairs are guaranteed for the remaining of the warranty on the original product or 90 days. The longest period will prevail.

8 – All repairs made at the **THERMOLEC LTÉE.** plant are guaranteed for 30 days from the date of repairs.

Specifications

The *DCC – Charge controller for electric vehicle* is a safety device with a programmable controller that can protect an electrical distribution circuit in relation with its main breaker. It will prevent overloading the electrical distribution circuit by turning off momentarily the power to the charging station when the demand exceeds 80% of the main breaker rating.

DESCRIPTION	SPECIFICATIONS
Models	DCC-9, DCC-10
Revision	V2
Company	THERMOLEC LTÉE.
Voltage and wiring (V)	240V AC single phase: L1, L2, ground
Main entrance / Main breaker	DCC-9 : Dip switch programmable for 100A and 125A. DCC-10 : Dip switch programmable for 100A, 125A, 150A, 200A.
Branch circuit breaker for Electric Vehicle Supply Equipment	40A circuit breaker included. The electrical vehicle maximum charge is 32A (charging station level 2)
Frequency	50 to 60 Hz
Dimensions*	DCC-9 : Height : 12.0" (305 mm) width : 12.0" (305 mm) Depth : 7.5" (203 mm) DCC-10 : Height : 11.0" (279 mm) width : 11.0" (279 mm) Depth : 4.5" (114 mm)
Total weight (lb / kg)*	DCC-9 : 15 lb (7,5 kg) DCC-10 : 12 lb (5,0 kg)
Operating temperature	32°F to 113°F (0°C to 45°C)
Storage temperature	-4°F to 158°F (-20°C to 70°C)
Approval	CSA US, for the United States and Canada. CAN/CSA C22.2 14-13 UL 508, 17 th Ed.

* Approximative, may change without notice

Characteristics

Conditions for application

The *DCC – Charge controller for electric vehicle* is designed to be use in a situation where a condominium, house or residence existing electrical installation will not allow the additional load of a charging station.

The *DCC – Charge controller for electric vehicle* allows the connection of an electric vehicle to an electrical network when the electrical panel is not accessible or when the main electrical panel is fully loaded.

Installations types

Multiple installation



Wall installation



Ceiling installation



Maximum power input (CB)

The *DCC – Charge controller for electric vehicle* can be powered by a 100A, 125A, 150A or 200A, 240V AC single phase source. The following options are available for each *DCC* model:

DCC-9: 100A and 125A

DCC-10: 100A, 125A, 150A and 200A

Electric Vehicle Supply Equipment (EVSE)

The *DCC – Charge controller for electric vehicle* will provide power to a charging station through a 40A, 240V AC circuit breaker, L1, L2 and ground. The *DCC* is equipped with a 40A Square D circuit breaker (QU0240).

Power failure

In the event of a power failure, the *DCC – Charge controller for electric vehicle* restore the power supply to the vehicle charging station when power returns.

Recovery time (RT)

Following a power failure to the electric vehicle supply equipment (EVSE), a 15 minutes' delay is initiated to monitor the total consumption of the electrical power system. Power to the vehicle will then be restored if the total load consumption is lower than 80% of the main circuit breaker rating during a period exceeding the 15 minutes' recovery time.

Types of connection

DCC Condo (model: DCC-9)

For condo and multi-unit's buildings with an accessible electric meter.

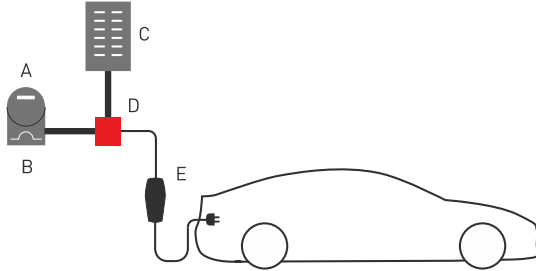

- A = Unit electric meter
- B = Main breaker
- C = Electric panel
- D = Charge controller and current transformer (CT)
- E = Charging station

DCC Home (model: DCC-10)

For a house with an electric panel fully loaded.

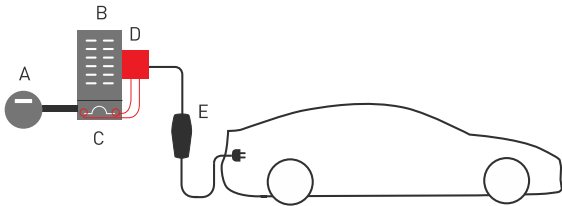

- A = Unit electric meter
- B = Electric panel
- C = Main breaker
- D = Charge controller and current transformer (CT)
- E = Charging station

DCC installation

Step 1: Check the package contents

DCC Condo (model: DCC – 9)



- 1 x DCC
- 1 x Ceiling mounting support
- 1 x Installation manual
- 2 x pre-wired current transformer (CT)

DCC Home (model: DCC – 10)



- 1 x DCC
- 1 x Ceiling mounting support
- 1 x Installation manual
- 2 x Current transformer (CT)

Step 2: Preparations for installation

1. Disconnect the main power supply.

2. Select the DCC intended location.

The *DCC* can be:

- ceiling mounted or
- wall mounted

NOTE: The DCC controller must be mounted so that the nameplate remains visible at all times.

For the DCC-10:

- Select an intended location preferably less than 6 feet's away from the electric panel (power source). The current transformers supplied have a wiring of 6 feet's in length, but can be extended to 18 feet's (see the section *current transformers (CT) installation and connections for the DCC-10 - Step 4: Conductor connexions* for the extension details).

Do not install the DCC:

- Outdoor
- In a location with high level of risk.
- Nearby inflammable materials, explosives or fuels, chemical products and vapors.

3. Before installation, check the DCC mounting position

Wall installation

Refer to the information on the enclosure to insure proper installation (see figure 1).

Ceiling installation

The installation may be done in any direction.

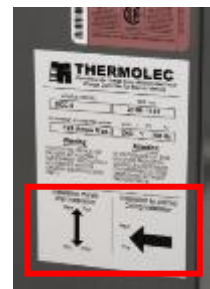

Figure 1 – Information's on the enclosure side

Step 3: Installation

Ceiling installation

1. Remove the 4 cover screws.
2. Fix the ceiling mounting support on the *DCC* (see figure 2)
3. Lift the *DCC* using the ceiling mounting support (see figure 3).
4. Position the *DCC* at the intended location. (see Figure 4).
5. Fix the *DCC* with the anchors for the type of surface.
6. Check that the *DCC* is adequately fixed to the wall or ceiling.
7. Remove the ceiling mounting support (see Figure 5).



Figure 2



Figure 3



Figure 4



Figure 5

Wall installation

1. Remove the 4 cover screws.
2. Position the *DCC* at the intended location.
3. Ensure that the mounting is according with the information's on the enclosure.
4. Fix the *DCC* with the anchors provided for the type of surface.
5. Check that the *DCC* is adequately fixed to the wall or ceiling.

Step 4: Conductor connexions

DCC-9 Consult the diagram below for all details on the cable connections configuration. These diagrams are also found under the DCC cover.

BOITIER DE CONTROLE DCC-9

LEGENDE

M	CONTACTEUR DE CHARGE
DCC	CONTROLEUR ELECTRONIQUE
F	FUSIBLE
CB	DISJONCTEUR
T	TRANSFORMATEUR
CT	TRANSFORMATEUR DE COURANT

IMPORTANT

Suivre les codes électriques nationaux et locaux ainsi que les instructions contenues dans l'appareil.

LEGEND

M	LOAD SHED CONTACTOR
DCC	ELECTRONIC CONTROLLER
F	FUSE
CB	CIRCUIT BREAKER
T	TRANSFORMER
CT	CURRENT TRANSFORMER

IMPORTANT

Wire in accordance with local & Canadian Electrical codes. Read instructions carefully before wiring and operating.

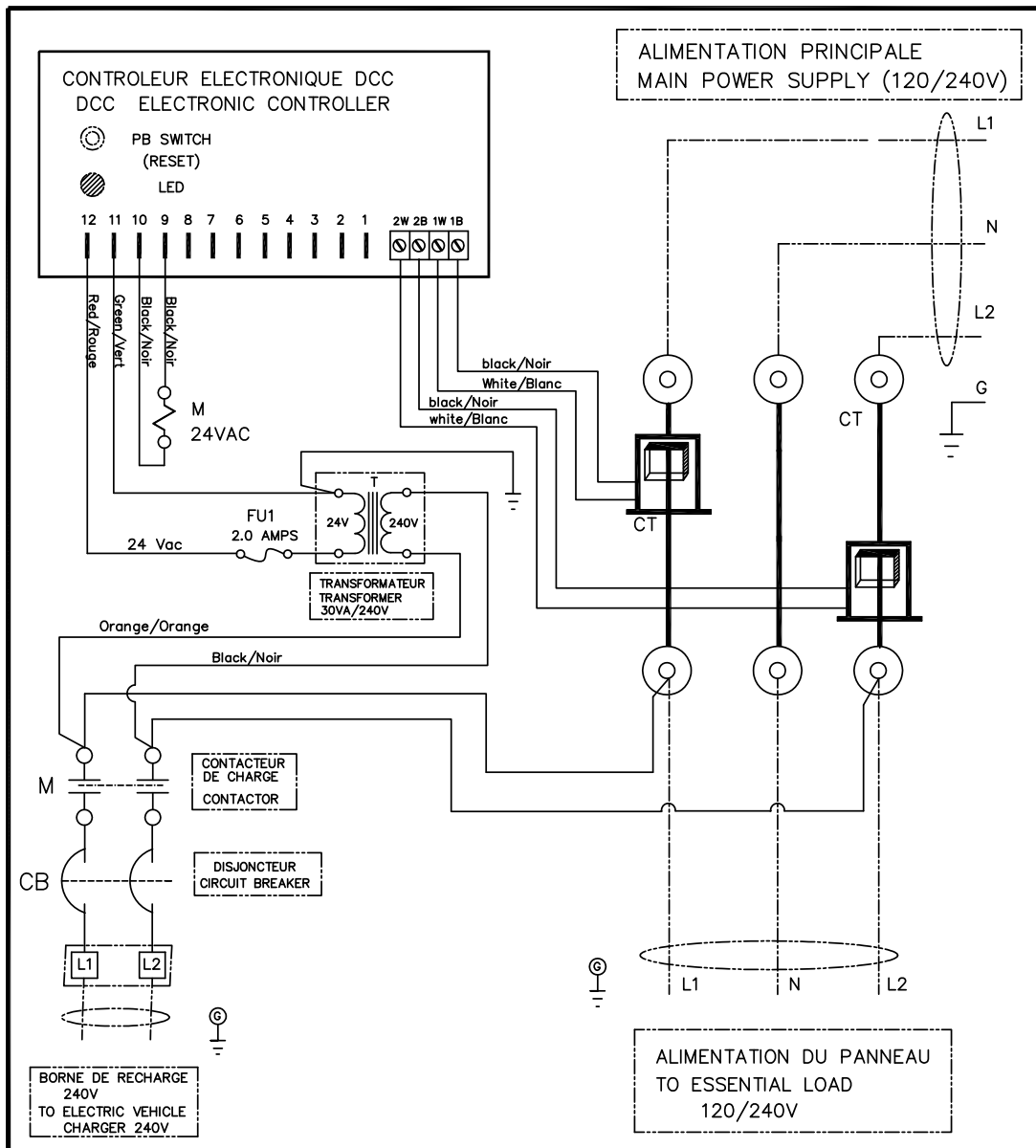

DCC-10 Consult the diagram below for all details on the cable connections configuration. These diagrams are also found under the DCC cover.

BOITIER DE CONTROLE DCC-10

LEGENDE

M CONTACTEUR DE CHARGE
 DCC CONTROLEUR ELECTRONIQUE
 F FUSIBLE
 CB DISJONCTEUR
 T TRANSFORMATEUR
 CT TRANSFORMATEUR DE COURANT

LEGEND

M LOAD SHED CONTACTOR
 DCC ELECTRONIC CONTROLLER
 F FUSE
 CB CIRCUIT BREAKER
 T TRANSFORMER
 CT CURRENT TRANSFORMER

IMPORTANT

Suivre les codes électriques nationaux et locaux ainsi que les instructions contenues dans l'appareil.

IMPORTANT

Wire in accordance with local & Canadian Electrical codes. Read instructions carefully before wiring and operating.

À INSTALLER AUTOUR DES CÂBLES D'ALIMENTATION DU PANNEAU
 TO INSTALL AROUND THE POWER SUPPLY CABLE

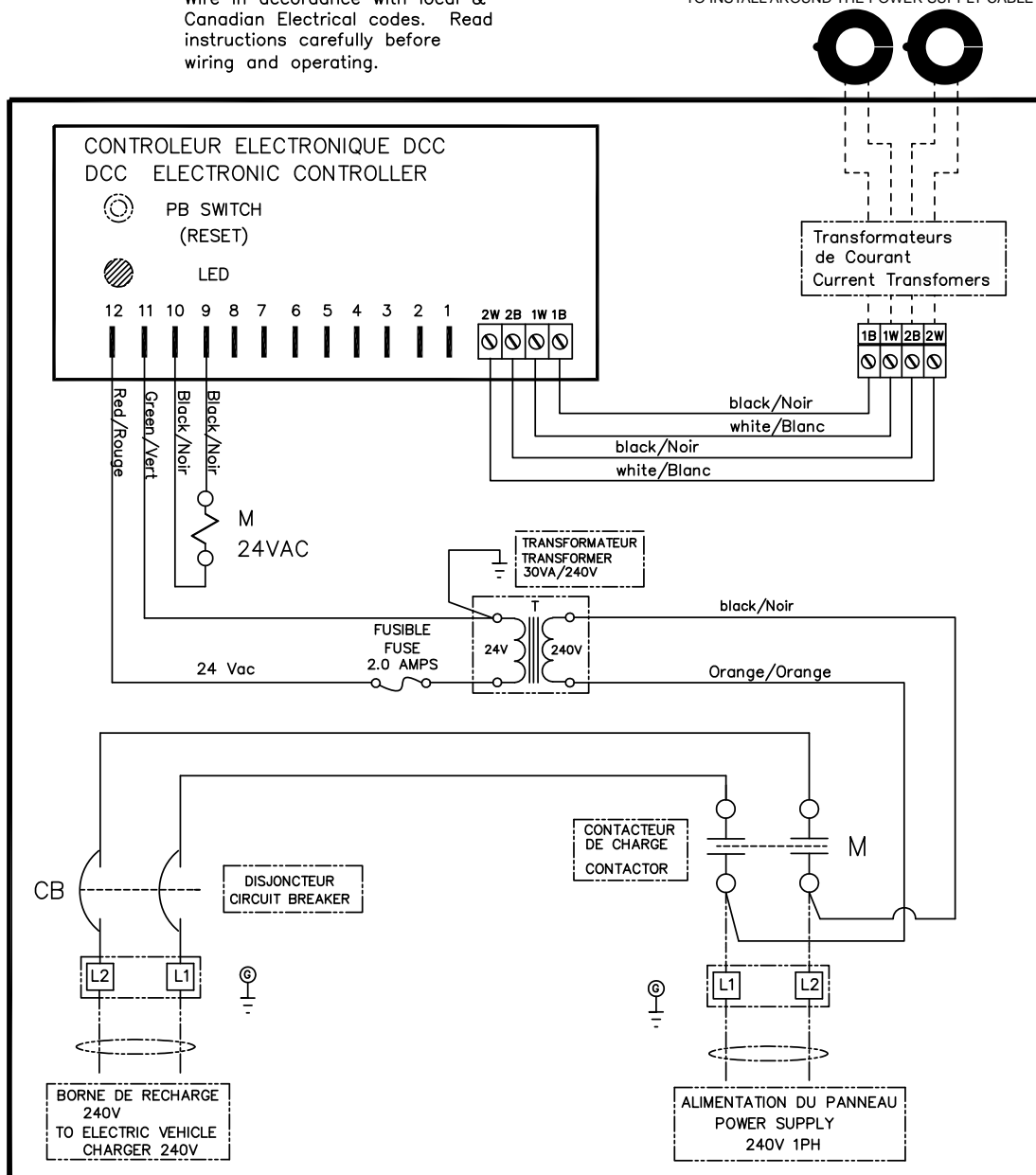

Current transformers(CT) installation and connections for the DCC-10

1. Open the CT (see Figure 6).
2. Install the CT around the main power cable of the panel (see Figure 7).
3. Check the correct polarity on the CTs.
4. Connect the CT cables to the terminal block, provided for that purpose, inside the DCC (see Figure 8).

The current transformers are supplied with a wiring of 2 feet's in length. It is possible to extend the CT cables to a maximum 18 feet's. Use only a cable with SHIELD (ex: FT4 SHIELD. 4C FAS #18).



Figure 6



Figure 7



Figure 8

Step 5: Dip switch programming for main power supply

1. Identify the set-up section on the DCC (see figure 8, red rectangle).



Figure 8

Legend :



2. Set up the section as per the layout corresponding to the main power supply:

DCC-9

WARNING: The **default** setting of the main power supply is **100A**.

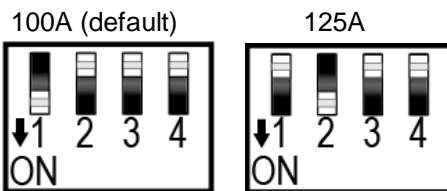

DCC-10

WARNING: The **default** setting of the main power supply is **100A**.

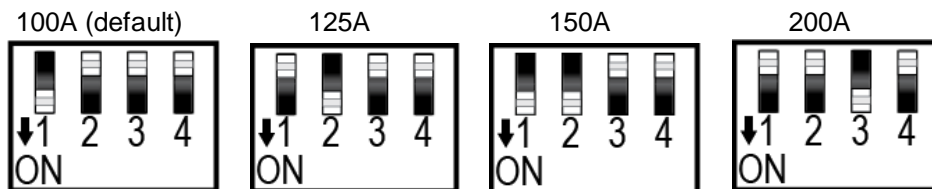

Step 6: Start-up

DCC power supply

1. Supply electrical power to the *DCC*.
2. Wait ten (10) seconds.
3. Check if the contactor is switched on.
4. Check the pilot light:
GREEN at all time (see Figure 9): compliant installation, go to the next step.
RED (see Figure 10): refer to the **Lights code** section.



Figure 9



Figure 10

Charging station power supply

1. Put the circuit breaker in the ON position.
2. Check if the electric vehicle supply equipment (EVSE) is powered.:
Electric vehicle supply equipment (EVSE) powered: go to the next step
Electric vehicle supply equipment (EVSE) not energized: check the charging station connections.

Step 7: Secure and re-energize

Secure

1. Turn off the power on the DCC.
2. Put the cover back (see Figure 11).



Figure 11

Re-energize

1. Supply electrical power to the DCC.

Step 8: Identification

1. Register all the information's of the charging station owner (address and parking space) (see Figure 12).
2. Register all configuration settings of the main power supply (essential load) in the space provided in the cover.
3. Register all configuration settings of the charging station in the space provided in the cover.



Figure 12

Application

Electric vehicle recovery time

Following a power failure to the electric vehicle supply equipment (EVSE), a 15 minutes' delay is initiated to monitor the total consumption of the electrical system. Power to the vehicle will then be restored if the total load consumption is lower than 80% of the main circuit breaker rating.











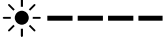

Electric vehicle charging time

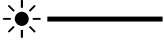
It is recommended to schedule the charging vehicle program during hours of low electrical consumption to minimize interruptions to the electric charging station.

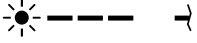
Maintenance

Do not use any cleaning solvents to clean the DCC.

Lights code

 Green		The charging station is energized.
 Green		The charging station is energized. The total load exceeds 80%. If the loads exceed 80% for a predetermined period, the charging station will be de-energized.
 Yellow		The charging station is not energized. The total loads exceed 80%. The resumption time will start when the total load is lower than 80%.
 Yellow		The charging station is not energized. The total load is lower than 80% and the recovery time is in progress. Each flash mean two (2) minutes before the resumption of power to the charging station. (ex: 3 flashes = 6 minutes before power to the charging station). During that period, if the total load exceeds 80%, the recovery time will restart from the beginning.
 Red		Malfunction. 1) Check all connections 2) Check if the current transformers are properly connected and interlocked. If the problem persists, call 450-902-1355 or info@rve.ca
 Red		Malfunction. Check all the dipswitch settings. If the problem persists, send a photo of the electronic card to info@rve.ca and then call 450-902-1355.
 Off		No power. Check the power source.